

NETGEAR Router Setup Manual

NETGEAR

NETGEAR, Inc.
4500 Great America Parkway
Santa Clara, CA 95054 USA

Version 1.0
August 2004

August 2004

Trademarks

NETGEAR is a trademark of Netgear, Inc.

Microsoft, Windows, and Windows NT are registered trademarks of Microsoft Corporation.

Other brand and product names are registered trademarks or trademarks of their respective holders.

Statement of Conditions

In the interest of improving internal design, operational function, and/or reliability, NETGEAR reserves the right to make changes to the products described in this document without notice.

NETGEAR does not assume any liability that may occur due to the use or application of the product(s) or circuit layout(s) described herein.

Federal Communications Commission (FCC) Compliance Notice: Radio Frequency Notice

This equipment has been tested and found to comply with the limits for a Class B digital device, pursuant to part 15 of the FCC Rules. These limits are designed to provide reasonable protection against harmful interference in a residential installation. This equipment generates, uses, and can radiate radio frequency energy and, if not installed and used in accordance with the instructions, may cause harmful interference to radio communications. However, there is no guarantee that interference will not occur in a particular installation. If this equipment does cause harmful interference to radio or television reception, which can be determined by turning the equipment off and on, the user is encouraged to try to correct the interference by one or more of the following measures:

- Reorient or relocate the receiving antenna.
- Increase the separation between the equipment and receiver.
- Connect the equipment into an outlet on a circuit different from that to which the receiver is connected.
- Consult the dealer or an experienced radio/TV technician for help.

EN 55 022 Declaration of Conformance

This is to certify that the Router is shielded against the generation of radio interference in accordance with the application of Council Directive 89/336/EEC, Article 4a. Conformity is declared by the application of EN 55 022 Class B (CISPR 22).

Bestätigung des Herstellers/Importeurs

Es wird hiermit bestätigt, daß das Router gemäß der im BMPT-AmtsblVfg 243/1991 und Vfg 46/1992 aufgeführten Bestimmungen entstört ist. Das vorschriftsmäßige Betreiben einiger Geräte (z.B. Testsender) kann jedoch gewissen Beschränkungen unterliegen. Lesen Sie dazu bitte die Anmerkungen in der Betriebsanleitung.

Das Bundesamt für Zulassungen in der Telekommunikation wurde davon unterrichtet, daß dieses Gerät auf den Markt gebracht wurde und es ist berechtigt, die Serie auf die Erfüllung der Vorschriften hin zu überprüfen.

Certificate of the Manufacturer/Importer

It is hereby certified that the Router has been suppressed in accordance with the conditions set out in the BMPT-AmtsblVfg 243/1991 and Vfg 46/1992. The operation of some equipment (for example, test transmitters) in accordance with the regulations may, however, be subject to certain restrictions. Please refer to the notes in the operating instructions.

Federal Office for Telecommunications Approvals has been notified of the placing of this equipment on the market and has been granted the right to test the series for compliance with the regulations.

Customer Support

Refer to the Support Information Card that shipped with your Router.

World Wide Web

NETGEAR maintains a World Wide Web home page that you can access at the universal resource locator (URL) <http://www.netgear.com>. A direct connection to the Internet and a Web browser such as Internet Explorer or Netscape are required.

Contents

Chapter 1

About This Guide

Audience, Conventions, and Formats	1-1
Tips for Printing This Manual	1-2

Chapter 2

Getting to Know Your NETGEAR Wireless Router

Package Contents	2-1
The Front Panel	2-2
The Rear Panel	2-3

Chapter 3

Connecting the Router to the Internet

Prepare to Install Your Wireless Router	3-1
First, Connect the Wireless Router to the Internet	3-1
Now, Set Up a Computer for Wireless Connectivity	3-6
Troubleshooting Tips	3-7
Overview of How to Access the Wireless Router	3-8
How to Log On to the Wireless Router After Configuration Settings Have Been Applied	3-9
How to Bypass the Configuration Assistant	3-10
How to Manually Configure Your Internet Connection	3-10
Using the Smart Setup Wizard	3-12
NETGEAR Product Registration, Support, and Documentation	3-13

Chapter 4

Optimizing Wireless Connectivity and Security

Observe Performance, Placement, and Range Guidelines	4-1
Implement Appropriate Wireless Security	4-2
Understanding Wireless Settings	4-3
Information to Gather Before Changing Basic Wireless Settings	4-6
Default Factory Settings	4-7

How to Set Up and Test Basic Wireless Connectivity	4-7
How to Configure WEP	4-9
How to Configure WPA-PSK Wireless Security	4-11
How to Restrict Wireless Access by MAC Address	4-11
Chapter 5	
Doing Basic Router Housekeeping	
Changing the Administrator Password	5-1
Configuration File Management	5-2
Restoring and Backing Up the Configuration	5-2
Erasing the Configuration	5-3
Upgrading the Wireless Router Software	5-3
Chapter 6	
Troubleshooting Common Problems	
Basic Functioning	6-1
Power Light Not On	6-1
Lights Never Turn Off	6-2
LAN or Internet (WAN) Port Lights Not On	6-2
Troubleshooting the Web Configuration Interface	6-2
Troubleshooting the ISP Connection	6-3
Troubleshooting a TCP/IP Network Using a Ping Utility	6-5
Testing the LAN Path to Your Router	6-5
Testing the Path from Your Computer to a Remote Device	6-6
Restoring the Default Configuration and Password	6-7
Appendix A	
Technical Specifications	
Glossary	
List of Glossary Terms	G-1

Chapter 1

About This Guide

This chapter describes the intended audience, scope, conventions, and formats of this manual.

Audience, Conventions, and Formats

This reference manual assumes that the reader has basic computer and Internet skills. However, basic computer network, Internet, and firewall technologies tutorial information is provided in the Appendices and on the Netgear Web site.

This guide uses the following format to highlight special messages:

	Note: This format is used to highlight information of importance or special interest.
---	--

This guide uses the following typographical conventions:

Table 1-1. Typographical Conventions

<i>italics</i>	Emphasis, books, CDs, URL names
bold	User input
SMALL CAPS	Screen text, file and server names, extensions, commands, IP addresses

	Note: Product updates are available on the NETGEAR Web site at http://kbserver.netgear.com .
---	---

Chapter 2

Getting to Know Your NETGEAR Wireless Router

NETGEAR routers provide connections for multiple computers to the Internet through an external broadband access device such as a cable modem or DSL modem that is normally intended for use by a single computer. This chapter introduces the NETGEAR Router.

Package Contents

The product package should contain the following items:

- Router.
- AC power adapter.
- Vertical stands.
- A Category 5 (CAT5) Ethernet cable.
- The Setup CD, including:
 - This guide.
 - Application Notes and other helpful information.
- Registration, Warranty Card, and Support Information Card.

If any of the parts are incorrect, missing, or damaged, contact your NETGEAR dealer. Keep the carton, including the original packing materials, in case you need to return the router for repair.

The Front Panel

The front panel of the router includes these status lights.

Figure 2-1: router Front Panel

You can use the status lights to verify connections. Viewed from left to right, the table below describes the lights on the front panel of the router.

Table 2-1. Status Light Descriptions

Label	Activity	Description
Power	On Green Solid Off	Power is supplied to the router. Power is not supplied to the router.
Test	Blinking Off	The router is performing its diagnostic test. The router successfully completed its diagnostic test.
Internet	On Blink	The Internet port has detected a link with an attached device. Data is being transmitted or received by the Internet port.
LAN	On (Green) Blink (Green) On (Yellow) Blink (Yellow) Off	The LAN (local area network) port has detected link with a 100 Mbps device. Data is being transmitted or received at 100 Mbps. The Local port has detected link with a 10 Mbps device. Data is being transmitted or received at 10 Mbps. No link is detected on this port.

The Router's Rear Panel

The rear panel of the Router contains these connections.

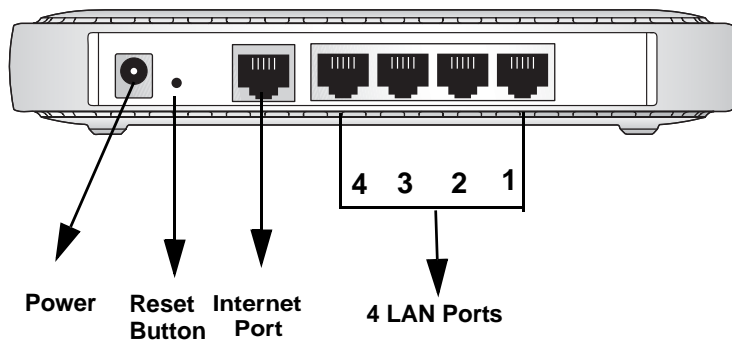

Figure 1-2: router Rear Panel

Viewed from left to right, the rear panel contains the following features:

- AC power adapter outlet for **5 V DC @ 1 A output, 20W maximum**
- Factory Default Reset push button for [Restoring the Default Configuration and Password](#)
- Internet (WAN) Ethernet port for connecting the router to a cable or DSL modem
- Four Local (LAN) 10/100 Mbps Ethernet ports for connecting the router to the local computers

Chapter 3

Connecting the Router to the Internet

This chapter describes how to set up the router on your local area network (LAN) and connect to the Internet. You will find out how to configure your router for Internet access.

Follow these instructions to set up your router.

Prepare to Install Your Router

- *For Cable Modem Service:* When you perform the router setup steps be sure to use the computer you first registered with your cable ISP.
- *For DSL Service:* You may need information such as the DSL login name/e-mail address and password in order to complete the router setup.

Before proceeding with the router installation, familiarize yourself with the contents of the Setup CD, especially this manual and the tutorials for configuring computers for networking.

First, Connect the Router to Your Network

1. CONNECT THE ROUTER, THE COMPUTER, AND THE MODEM
 - a. Turn off your computer.
 - b. Turn off the cable or DSL broadband modem *and* unplug it.

- c. Locate the Ethernet cable (Cable 1 in the diagram) that connects your PC to the modem.

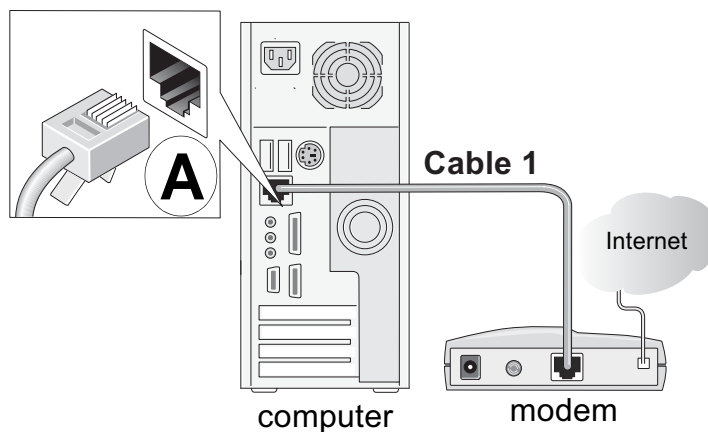

Figure 3-1: Disconnect the Ethernet cable from the computer

- d. Disconnect the cable at the computer end only, point **A** in the diagram above.
- e. Look at the label on the bottom of the router. Locate the Internet port. Securely insert the Ethernet cable from your modem (Cable 1 in the diagram below) into the Internet port of the router as shown in point **B** of the diagram below.

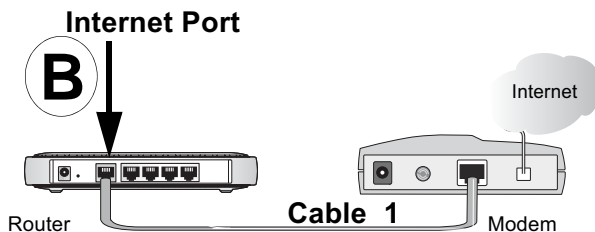

Figure 3-2: Connect the router to the modem

Note: Place the router in a location which conforms to the “[Observe Performance, Placement, and Range Guidelines](#)” on page 4-1. The stand provided with the router provides a convenient, space-saving way of installing the router. Avoid stacking it on other electronic equipment.

- f. Securely insert the blue cable that came with your router (the blue NETGEAR cable in the diagram below) into a LAN port on the router such as LAN port 4 (point **C** in the diagram), and the other end into the Ethernet port of your computer (point **D** in the diagram).

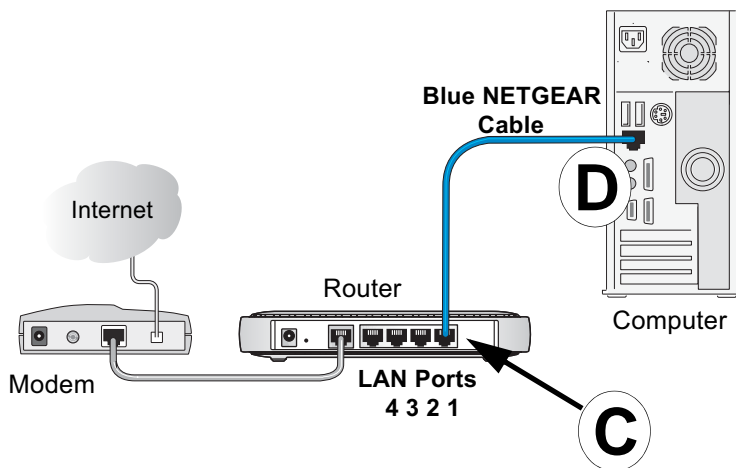

Figure 3-3: Connect the computer to the router

Your network cables are connected and you are ready to restart your network.

2. RESTART YOUR NETWORK IN THE CORRECT SEQUENCE

Warning: Failure to restart your network in the correct sequence could prevent you from connecting to the Internet.

- a. First, plug in and turn on the broadband modem and wait 2 minutes.
- b. Now, plug in the power cord to your router and wait 1 minute.
- c. Last, turn on your computer.

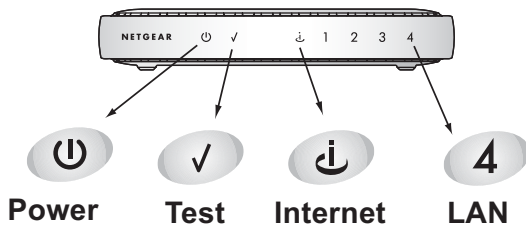

Figure 3-4: Verify the connections according to the status lights on the router

- d. Check the router status lights to verify the following:
 - *Power*: The power light should turn solid green. If it does not, see [“Troubleshooting Tips” on page 3-6](#).
 - *Test*: The test light should be off. The test light blinks when the router is first turned on then goes off. If after 2 minutes it is still on, see the Troubleshooting Tips below.
 - *Internet*: The Internet port light should be lit. If not, make sure the Ethernet cable is securely attached to the router Internet port and the modem, and the modem is powered on.
 - *LAN*: A LAN light should be lit. Green indicates your computer is communicating at 100 Mbps; yellow indicates 10 Mbps. If a LAN light is not lit, check that the Ethernet cable from the computer to the router is securely attached at both ends, and that the computer is turned on.

Use the Smart Wizard to Configure Your Router

For DSL customers, if your Internet service provider had you install software logs you in to the Internet, *do not* run that software. If such software automatically starts when you open a browser, you may need to go to the Internet Explorer Tools menu, Internet Options, Connections tab page where you can select “Never dial a connection.”

1. From the Ethernet connected computer you just set up, open a browser such as Internet Explorer or Netscape® Navigator.



Figure 3-5: Router welcome screen

In its factory default state, the router will display the NETGEAR Smart Wizard welcome page. Click **OK** to proceed.

Note: If you do not see this page, type <http://www.routerlogin.net> in the browser address bar and click Enter.

If you still cannot connect to the router, verify your computer networking setup. It should be set to obtain *both* IP and DNS server addresses automatically, which is usually so. For help with this, please see the *Reference Manual* or animated tutorials on the CD.

2. Follow the Smart Wizard prompts to connect to the Internet.

Note: The configuration assistant only appears when the router is in its factory default state. After you configure the router, it will not appear again. You can always connect to the router configuration menu to change its settings. To do so, open a browser and go to <http://www.routerlogin.net>. Then, when prompted, enter **admin** as the user name and **password** for the password both in lower case letters.

You are now connected to the Internet!

Troubleshooting Tips

Here are some tips for correcting simple problems you may have.

Be sure to restart your network in this sequence:

- 1) Turn off the modem, router, and computer
- 2) Turn on the modem, wait two minutes
- 3) Turn on the router and wait 1 minute
- 4) Turn on the computer.

Make sure the Ethernet cables are securely plugged in.

- The Internet status light on the router will be lit if the Ethernet cable from the modem is plugged in securely to the router and the modem and both are turned on.
- For each powered on computer connected to the router with a securely plugged in Ethernet cable, the corresponding router LAN port status light will be lit. The label on the bottom of the router identifies the number of each LAN port.

Make sure the network settings of the computer are correct.

- Computers connected to the router *must* be configured to obtain IP *and* DNS addresses automatically via DHCP. For help with this, please see the animated tutorials on the CD or the *Setup Manual* on the CD.
- Some cable modem ISPs require you to use the MAC address of the computer registered on the account. If so, in the Router MAC Address section of the Basic Settings menu, select, “Use this Computer’s MAC Address.” The router will then capture and use the MAC address of the computer that you are now using. You must be using the computer that is registered with the ISP. Click **Apply** to save your settings. Restart the network in the correct sequence.

Check the router status lights to verify correct router operation.

If the Power light does not turn solid green within 2 minutes of turning the router on, reset the router as described in the *Setup Manual* on the CD.

Advanced user access.

Technically advanced users who want to bypass the configuration assistant can do so by logging to the router at <http://www.routerlogin.net/basicsetting.htm> with the user name of admin and the password of password in lower case letters.

Product Registration, Support, and Documentation

Register your product at <http://www.NETGEAR.com/register>. Registration is required before you can use our telephone support service.

Product updates and Web support are always available by going to:
<http://kbserver.netgear.com/products/RP614v3.asp>.

Documentation is available on the CD and at
<http://kbserver.netgear.com/documentation/RP614v3.asp>.

When the router is connected to the Internet, click the Knowledge Base or the Documentation link under the Web Support menu to view support information or the documentation for the router.

Overview of How to Access the Router

The table below describes how you access the router, depending on the state of the router.

Table 3-1. Ways to access the router

Router State	Access Options	Description
Factory Default Note: The router is supplied in the factory default state. Also, the factory default state is restored when you use the factory reset button. See "Restoring the Default Configuration and Password" on page 7-7 for more information on this feature.	Automatic Access via the Smart Wizard Configuration Assistant	<p>Any time a browser is opened on any computer connected to the router, the router will automatically connect to that browser and display the Configuration Assistant welcome page.</p> <p>There is no need to enter the router URL in the browser, or provide the login user name and password.</p>
	Manually enter a URL to bypass the Smart Wizard Configuration Assistant	<p>You can bypass the Smart Wizard Configuration Assistant feature by typing http://www.routerlogin.net/basicsetting.htm in the browser address bar and clicking Enter. You will not be prompted for a user name or password.</p> <p>This will enable you to manually configure the router even when it is in the factory default state. When manually configuring the router, you must complete the configuration by clicking Apply when finished entering your settings. If you do not do so, a browser on any computer connected to the router will automatically display the router's Configuration Assistant Welcome page rather than the browser's home page.</p>
Configuration Settings Have Been Applied	Enter the standard URL to access the router	<p>Connect to the router by typing either of these URLs in the address field of your browser, then click Enter:</p> <ul style="list-style-type: none"> • http://www.routerlogin.net • http://www.routerlogin.com <p>The router will prompt you to enter the user name of admin and the password. The default password is password.</p>
	Enter the IP address of the router to access the configuration utility	<p>Connect to the router by typing the IP address of the router in the address field of your browser, then click Enter. 192.168.0.1 is the default IP address of the router. The router will prompt you to enter the user name of admin and the password. The default password is password.</p>

How to Log On to the Router After Configuration Settings Have Been Applied

1. Connect to the router by typing **http://www.routerlogin.net** in the address field of your browser, then click **Enter**.

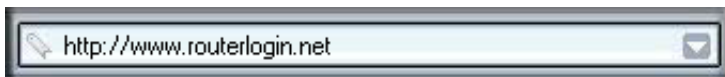

Figure 3-6: Login URL

2. For security reasons, the router has its own user name and password. When prompted, enter **admin** for the router user name and **password** for the router password, both in lower case letters. To change the password, see [“Changing the Administrator Password” on page 5-8.](#)

Note: The router user name and password are not the same as any user name or password you may use to log in to your Internet connection.

A login window like the one shown below opens:

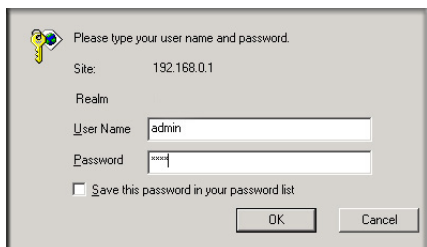

Figure 3-7: Login window

Once you have entered your user name and password, your Web browser should find the router and display the home page as shown below.

Setup Wizard

- Setup
 - Basic Settings
 - Content Filtering
 - Logs
 - Block Sites
 - Block Services
 - Schedule
 - E-mail
- Maintenance
 - Router Status
 - Attached Devices
 - Backup Settings
 - Set Password
 - Router Upgrade
- Advanced
 - Port Forwarding
 - Port Triggering
 - WAN Setup
 - LAN IP Setup
 - Dynamic DNS
 - Static Routes
 - Remote Management
 - UPnP
- Web Support
 - Knowledge Base
- Logout

Basic Settings

Does Your Internet Connection Require A Login?

Yes
 No

Internet Service Provider Other

Login

Password

Service Name (If Required)

Idle Timeout (In Minutes) 5

Domain Name Server (DNS) Address

Get Automatically From ISP
 Use These DNS Servers

Primary DNS: 0 0 0 0

Secondary DNS: 0 0 0 0

Cancel Apply

Help

The RP614 Settings pages allow you to configure, upgrade and check the status of your NETGEAR Cable/DSL Router.

Click an item in the leftmost column. The current settings or information for that area appear in the center column.

Helpful information related to the selected Settings page appears in this column. If you are using Internet Explorer, you may click an item in the center column to jump directly to the related help section; otherwise, scroll down until you reach it.

Basic Settings Help

Note: If you are setting up the router for the first time, the default settings may work for you with no changes.

Does Your Internet Connection Require A Login?

Select this option based on the type of account you have with your ISP. If you need to enter login information every time you connect to the Internet or you have a PPPoE account with your ISP, select **Yes**. Otherwise, select **No**.

Note: If you have installed PPP software such as WinPoET (from Earthlink), Enternet (from PacBell) or AOL Broadband software, then you have PPPoE. Select **Yes**.

Internet Service Provider

Select your ISP if it is listed in the pull down menu, otherwise select **Other**.

AOL Broadband DSL or Cable

If AOL Cable or AOL DSL is selected the router will automatically be configured with the required

Figure 3-8: Login result: router home page

The browser will then display the router settings home page.

When the router is connected to the Internet, click the Knowledge Base or the Documentation link under the Web Support menu to view support information or the documentation for the router.

If you do not click Logout, the router will wait 5 minutes after there is no activity before it automatically logs you out.

How to Bypass the Configuration Assistant

1. When the router is in the factory default state, type **http://www.routerlogin.net/basicsetting.htm** in the address field of your browser, then click **Enter**.

When the router is in the factory default state, a user name and password are not required.

2. The browser will then display the router settings home page shown in [“Login result: RP614 v3 home page”](#) on page 3-10.

If you do not click Logout, the router will wait 5 minutes after there is no activity before it automatically logs you out.

How to Manually Configure Your Internet Connection

You can manually configure your router using the menu below, or you can allow the Setup Wizard to determine your configuration as described in the previous section.

ISP Does Not Require Login

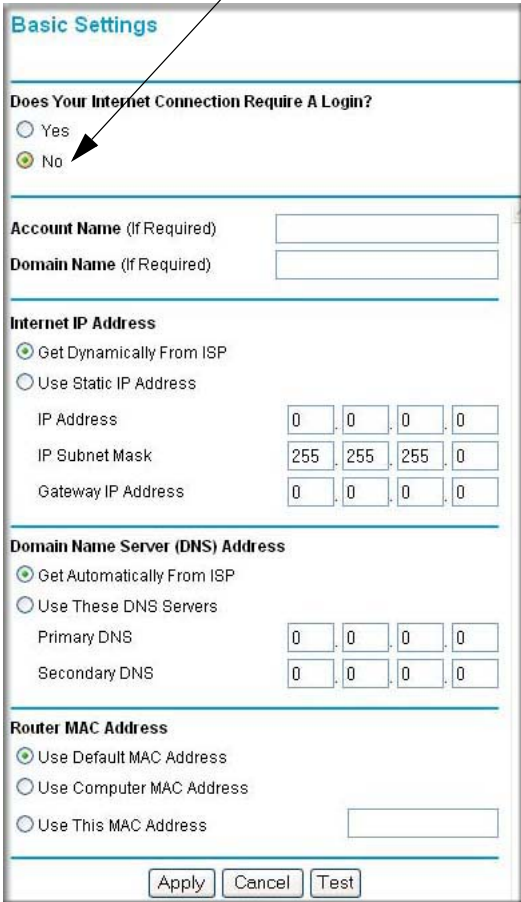

ISP Does Require Login

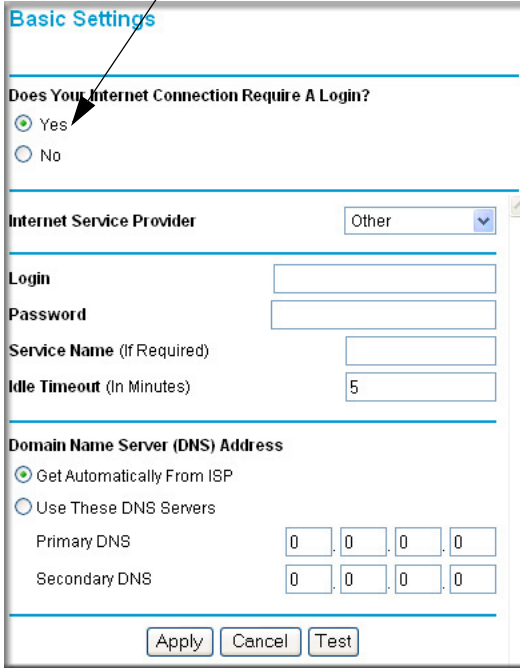

Figure 3-9: Browser-based configuration Basic Settings menus

You can manually configure the router using the Basic Settings menu shown in [Figure 3-9](#) using these steps:

1. Connect to the router by typing **http://www.routerlogin.net** in the address field of your browser, then click **Enter**.

2. For security reasons, the router has its own user name and password. When prompted, enter **admin** for the router user name and **password** for the router password, both in lower case letters.
3. Click **Basic Settings** on the Setup menu.
4. If your Internet connection does not require a login, click No at the top of the Basic Settings menu and fill in the settings according to the instructions below. If your Internet connection does require a login, click Yes, and skip to step 5.
 - a. Enter your Account Name (may also be called Host Name) and Domain Name.
These parameters may be necessary to access your ISP's services such as mail or news servers.
 - b. Internet IP Address:
If your ISP has assigned you a permanent, fixed (static) IP address for your computer, select "Use static IP address". Enter the IP address that your ISP assigned. Also enter the netmask and the Gateway IP address. The Gateway is the ISP's router to which your router will connect.
 - c. Domain Name Server (DNS) Address:
If you know that your ISP does not automatically transmit DNS addresses to the router during login, select "Use these DNS servers" and enter the IP address of your ISP's Primary DNS Server. If a Secondary DNS Server address is available, enter it also.
Note: If you enter an address here, restart the computers on your network so that these settings take effect.
 - d. Gateway's MAC Address:
This section determines the Ethernet MAC address that will be used by the router on the Internet port. Some ISPs will register the Ethernet MAC address of the network interface card in your computer when your account is first opened. They will then only accept traffic from the MAC address of that computer. This feature allows your router to masquerade as that computer by "cloning" its MAC address.

To change the MAC address, select "**Use this Computer's MAC address.**" The router will then capture and use the MAC address of the computer that you are now using. You must be using the one computer that is allowed by the ISP. Or, select "Use this MAC address" and type in the MAC address.
 - e. Click **Apply** to save your settings.
5. If your Internet connection does require a login, fill in the settings according to the instructions below. Select Yes if you normally must launch a login program such as Enternet or WinPOET in order to access the Internet.

Note: After you finish setting up your router, you will no longer need to launch the ISP's login program on your computer in order to access the Internet. When you start an Internet application, your router will automatically log you in.

- a. Select your Internet service provider from the drop-down list.

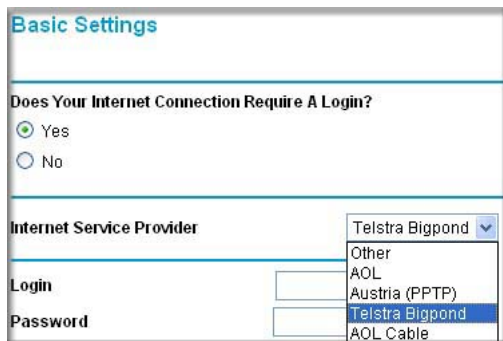

The screenshot shows a web interface titled "Basic Settings". It contains a section "Does Your Internet Connection Require A Login?" with radio buttons for "Yes" (selected) and "No". Below this is the "Internet Service Provider" dropdown menu, which is open and shows a list of options: "Telstra Bigpond", "Other", "AOL", "Austria (PPTP)", "Telstra Bigpond" (highlighted), and "AOL Cable". To the left of the dropdown are input fields for "Login" and "Password".

Figure 3-10: Basic Settings ISP list

Note: Not all ISPs are listed here. The ones on this list have special requirements.

- b. The screen will change according to the ISP settings requirements of the ISP you select.
- c. Fill in the parameters for your Internet service provider.
- d. Click **Apply** to save your settings. Click the Test button to verify you have Internet access.

Using the Smart Setup Wizard

You can use the Smart Setup Wizard to assist with manual configuration or to verify the Internet connection. The Smart Setup Wizard is not the same as the Smart Wizard configuration assistant (as illustrated in [Figure 3-5](#)) that only appears when the router is in its factory default state. After you configure the router, the Smart Wizard configuration assistant will not appear again.

To use the Smart Setup Wizard to assist with manual configuration or to verify the Internet connection settings, follow this procedure.

1. Connect to the router by typing **http://www.routerlogin.net** in the address field of your browser, then click **Enter**.

2. For security reasons, the router has its own user name and password. When prompted, enter **admin** for the router user name and **password** for the router password, both in lower case letters. To change the password, see [“Changing the Administrator Password” on page 5-8](#)

Note: The router user name and password are not the same as any user name or password you may use to log in to your Internet connection.

Once you have entered your user name and password, your Web browser should find the router and display the home page as shown in [“Login result: RP614 v3 home page” on page 3-10](#).

3. Click **Setup Wizard** on the upper left of the main menu.
4. Click **Next** to proceed. Input your ISP settings, as needed.
5. At the end of the Setup Wizard, click the **Test** button to verify your Internet connection. If you have trouble connecting to the Internet, use the Troubleshooting Tips [“Troubleshooting Tips” on page 3-6](#) to correct basic problems, or refer to [Chapter 7, “Troubleshooting.”](#)

Chapter 5

Doing Basic Router Housekeeping

This chapter describes how to use some of the maintenance features of your Router. These features can be found by clicking on the Maintenance heading in the Main Menu of the browser interface. Other maintenance features not presented in this chapter can be found accessed via links in the browser interface of the router to the User Guide and in the help screens.

Changing the Administrator Password



Note: Before changing the router password, follow the instructions under “[Configuration File Management](#)” on [page 5-2](#) to save your configuration settings. If you forget the new password, you will have to reset the router back to the factory defaults to be able to log in using the default password of password. This means you will have to restore all the router configuration settings. If you ever have to reset the router back to the factory defaults, you can restore your settings from the backup configuration file.

The default password for the router’s Web Configuration Manager is **password**. Change this password to a more secure password.

From the Main Menu of the browser interface, under the Maintenance heading, select Set Password to bring up the menu shown below.

Change Password

Old password

New password

Repeat new password

Figure 5-1: Set Password menu

To change the password, first enter the old password, then enter the new password twice. Click Apply.

Configuration File Management

The configuration settings of the router are stored within the router in a configuration file. This file can be saved (backed up) to a user's PC, retrieved (restored) from the user's PC, or cleared to factory default settings.

From the Main Menu of the browser interface, under the Maintenance heading, select the Settings Backup heading to bring up the menu shown below.

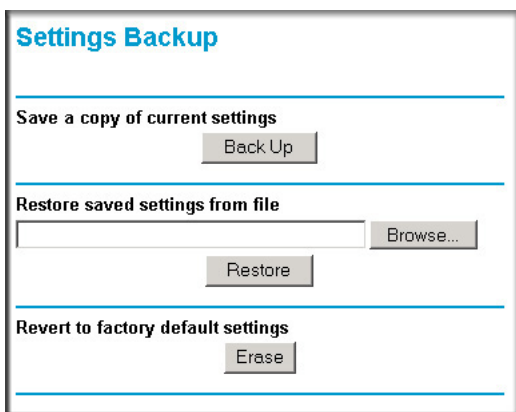

Figure 5-2: Settings Backup menu

Three options are available, and are described in the following sections.

Restoring and Backing Up the Configuration

The Restore and Backup options in the Settings Backup menu allow you to save and retrieve a file containing your router's configuration settings.

To save your settings, click the Backup button. Your browser will extract the configuration file from the router and will prompt you for a location on your PC to store the file. You can give the file a meaningful name at this time, such as pacbell.cfg.

To restore your settings from a saved configuration file, enter the full path to the file on your PC or click the Browse button to browse to the file. When you have located it, click the Restore button to send the file to the router. The router will then reboot automatically.

Warning: Do not interrupt the reboot process.

Erasing the Configuration

It is sometimes desirable to restore the router to original default settings. This can be done by using the Erase function, which will restore all factory settings. After an erase, the router's password will be **password**, the LAN IP address will be 192.168.0.1, and the router's DHCP client will be enabled.

To erase the configuration, click the Erase button.

To restore the factory default configuration settings without knowing the login password or IP address, you must use the Default Reset button on the rear panel of the router. See [“Restoring the Default Configuration and Password” on page 6-7](#).

Upgrading the Router Software



Note: Before upgrading the router software, use the router backup utility to save your configuration settings. Any router upgrade will revert the router settings back to the factory defaults. After completing the upgrade, you can restore your settings from the backup.

The routing software of the router is stored in FLASH memory, and can be upgraded as new software is released by NETGEAR. Upgrade files can be downloaded from the NETGEAR Web site. If the upgrade file is compressed (.ZIP file), you must first extract the file before sending it to the router. The upgrade file can be sent to the router using your browser.

Note: The Web browser used to upload new firmware into the router must support HTTP uploads. NETGEAR recommends using Microsoft Internet Explorer or Netscape Navigator 3.0 or above.

From the Main Menu of the browser interface, under the Maintenance heading, select the Router Upgrade link display the menu shown below.

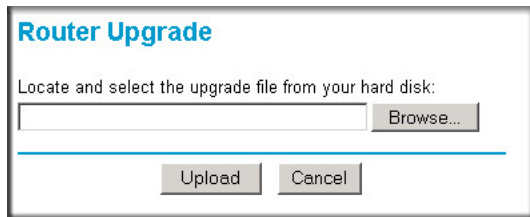

Figure 5-3: Router Upgrade menu

To upload new firmware:

1. Download and unzip the new software file from NETGEAR.
2. In the Router Upgrade menu, click the Browse button and browse to the location of the upgrade file
3. Click Upload.

Note: When uploading software to the router, it is important not to interrupt the Web browser by closing the window, clicking a link, or loading a new page. If the browser is interrupted, it may corrupt the software. When the upload is complete, your router will automatically restart. The upgrade process will typically take about one minute.

In some cases, you may need to reconfigure the router after upgrading.

Chapter 6

Troubleshooting Common Problems

This chapter gives information about troubleshooting your Router. After each problem description, instructions are provided to help you diagnose and solve the problem.

Basic Functioning

After you turn on power to the router, the following sequence of events should occur:

1. When power is first applied, verify that the Power light  is on.
2. After approximately 10 seconds, verify that:
 - a. The power light is solid green.
 - b. The LAN port lights are lit for any local ports that are connected.
 - c. The Internet port light is lit.

If a port's light is lit, a link has been established to the connected device. If a LAN port is connected to a 100 Mbps device, verify that the port's light is green. If the port is 10 Mbps, the light will be amber.

If any of these conditions does not occur, refer to the appropriate following section.

Power Light Not On

If the Power and other lights are off when your router is turned on:

- Make sure that the power cord is properly connected to your router and that the power supply adapter is properly connected to a functioning power outlet.
- Check that you are using the [5 V DC @ 1 A output, 20W maximum](#) power adapter supplied by NETGEAR for this product.

If the error persists, you have a hardware problem and should contact technical support.

Lights Never Turn Off

When the router is turned on, the lights turn on for about 10 seconds and then turn off. If all the lights stay on, there is a fault within the router.

If all lights are still on one minute after power up:

- Cycle the power to see if the router recovers.
- Clear the router's configuration to factory defaults. This will set the router's IP address to 192.168.0.1. This procedure is explained in [“Restoring the Default Configuration and Password” on page 6-7](#).

If the error persists, you might have a hardware problem and should contact technical support.

LAN or Internet (WAN) Port Lights Not On

If either the LAN lights or Internet light do not light when the Ethernet connection is made, check the following:

- Make sure that the Ethernet cable connections are secure at the router and at the hub or workstation.
- Make sure that power is turned on to the connected hub or workstation.
- Be sure you are using the correct cable:
 - When connecting the router's Internet port to a cable or DSL modem, use the cable that was supplied with the cable or DSL modem. This cable could be a standard straight-through Ethernet cable or an Ethernet crossover cable.

Troubleshooting the Web Configuration Interface

If you are unable to access the router's Web Configuration interface from a computer on your local network, check the following:

- Check the Ethernet connection between the computer and the router as described in the previous section.

- Make sure your computer's IP address is on the same subnet as the router. If you are using the default addressing schemes, your computer's address should be in the range of 192.168.0.2 to 192.168.0.254. Refer to [“Verifying TCP/IP Properties” on page C-8](#) or [“Verifying TCP/IP Properties for Macintosh Computers” on page C-19](#) to find your computer's IP address. Follow the instructions in [Appendix C](#) to configure your computer.

Note: If your computer's IP address is shown as 169.254.x.x, the computer is not configured correctly for your network. Recent versions of Windows and MacOS will generate and assign a 169.254.x.x IP address if the computer cannot reach a DHCP server. These auto-generated addresses are in the range of 169.254.x.x. If your IP address is in this range, check the connection from the computer to the router and reboot your computer.

- Make sure your browser has Java, JavaScript, or ActiveX enabled. If you are using Internet Explorer, click Refresh to be sure the Java applet is loaded.
- Try quitting the browser and launching it again.
- Make sure you are using the correct login information. The URL for the router is <http://www.routerlogin.net> or <http://www.routerlogin.com>. The factory default login name is **admin** and the password is **password**, both in lower case letters. Make sure that CAPS LOCK is off when entering this information.

If the router does not save changes you have made in the Web Configuration Interface, check the following:

- When entering configuration settings, be sure to click the APPLY button before moving to another menu or tab, or your changes are lost.
- Click the Refresh or Reload button in the Web browser. The changes may have occurred, but the Web browser may be caching the old configuration.

Troubleshooting the ISP Connection

If your router is unable to access the Internet, you should first determine whether the router is able to obtain a WAN IP address from the ISP. Unless you have been assigned a static IP address, your router must request an IP address from the ISP. You can determine whether the request was successful using the Web Configuration Manager.

To check the WAN IP address:

1. Launch your browser and select an external site such as www.netgear.com
2. Access the Main Menu of the router's configuration at <http://www.routerlogin.net>.

3. Under the Maintenance heading, select Router Status
4. Check that an IP address is shown for the WAN Port
If 0.0.0.0 is shown, your router has not obtained an IP address from your ISP.

If your router is unable to obtain an IP address from the ISP, you may need to force your cable or DSL modem to recognize your new router by performing the following procedure:

1. Turn off power to the cable or DSL modem.
2. Turn off power to your router.
3. Wait five minutes and reapply power to the cable or DSL modem.
4. When the modem's lights indicate that it has reacquired sync with the ISP, reapply power to your router.
5. Then restart your computer.

If your router is still unable to obtain an IP address from the ISP, the problem may be one of the following:

- Your ISP may require a login program.
Ask your ISP whether they require PPP over Ethernet (PPPoE) or some other type of login.
- If your ISP requires a login, you may have incorrectly set the login name and password in the router.
- Your ISP may check for your computer's host name.
Assign the computer Host Name of your ISP account as the Account Name in the Basic Settings menu.
- Your ISP only allows one Ethernet MAC address to connect to Internet, and may check for your computer's MAC address. In this case:
Inform your ISP that you have bought a new network device, and ask them to use the router's MAC address.

OR

Configure your router to spoof your computer's MAC address. This can be done in the Basic Settings menu.

If your router can obtain an IP address, but your computer is unable to load any Web pages from the Internet:

- Your computer may not recognize any DNS server addresses.

A DNS server is a host on the Internet that translates Internet names (such as www addresses) to numeric IP addresses. Typically your ISP will provide the addresses of one or two DNS servers for your use. If you entered a DNS address during the router's configuration, reboot your computer and verify the DNS address as described in [“Install or Verify Windows Networking Components” on page C-9](#). Alternatively, you may configure your computer manually with DNS addresses, as explained in your operating system documentation.

- Your computer may not have the router configured as its TCP/IP gateway.

If your computer obtains its information from the router by DHCP, reboot the computer and verify the gateway address as described in [“Install or Verify Windows Networking Components” on page C-9](#).

Troubleshooting a TCP/IP Network Using a Ping Utility

Most TCP/IP terminal devices and routers contain a ping utility that sends an echo request packet to the designated device. The device then responds with an echo reply. Troubleshooting a TCP/IP network is made very easy by using the ping utility in your computer or workstation.

Testing the LAN Path to Your Router

You can ping the router from your computer to verify that the LAN path to your router is set up correctly.

To ping the router from a running Windows 95 or later:

1. From the Windows toolbar, click on the Start button and select Run.
2. In the field provided, type Ping followed by the IP address of the router, as in this example:

```
ping 192.168.0.1
```

3. Click on OK.

You should see a message like this one:

```
Pinging <IP address> with 32 bytes of data
```

If the path is working, you see this message:

```
Reply from < IP address >: bytes=32 time=NN ms TTL=xxx
```

If the path is not working, you see this message:

```
Request timed out
```

If the path is not functioning correctly, you could have one of the following problems:

- Wrong physical connections
 - Make sure the LAN port LED is on. If the LED is off, follow the instructions in [“LAN or Internet \(WAN\) Port Lights Not On”](#) on page 6-2.
 - Check that the corresponding Link LEDs are on for your network interface card and for the hub ports (if any) that are connected to your workstation and router.
- Wrong network configuration
 - Verify that the Ethernet card driver software and TCP/IP software are both installed and configured on your computer or workstation.
 - Verify that the IP address for your router and your workstation are correct and that the addresses are on the same subnet.

Testing the Path from Your Computer to a Remote Device

After verifying that the LAN path works correctly, test the path from your computer to a remote device. From the Windows run menu, type:

```
PING -n 10 <IP address>
```

where *<IP address>* is the IP address of a remote device such as your ISP's DNS server.

If the path is functioning correctly, replies as in the previous section are displayed. If you do not receive replies:

- Check that your computer has the IP address of your router listed as the default gateway. If the IP configuration of your computer is assigned by DHCP, this information will not be visible in your computer's Network Control Panel. Verify that the IP address of the router is listed as the default gateway as described in [“Install or Verify Windows Networking Components”](#) on page C-9.
- Check to see that the network address of your computer (the portion of the IP address specified by the netmask) is different from the network address of the remote device.
- Check that your cable or DSL modem is connected and functioning.
- If your ISP assigned a host name to your computer, enter that host name as the Account Name in the Basic Settings menu.

- Your ISP could be rejecting the Ethernet MAC addresses of all but one of your computers. Many broadband ISPs restrict access by only allowing traffic from the MAC address of your broadband modem, but some ISPs additionally restrict access to the MAC address of a single computer connected to that modem. If this is the case, you must log in to the router and use the Basic Settings menu to configure your router to “clone” or “spoof” the MAC address from the authorized computer.

Restoring the Default Configuration and Password

This section explains how to restore the factory default configuration settings, changing the router’s administration password to **password**. You can erase the current configuration and restore factory defaults in two ways:

- Use the Erase function of the router (see [“Erasing the Configuration” on page 5-3](#)).
- Use the Default Reset button on the rear panel of the router. Use this method for cases when the administration password or IP address is not known.

To restore the factory default configuration settings without knowing the administration password or IP address, you must use the Default Reset button on the rear panel of the router.

1. Press and hold the Default Reset button until the power light blinks on (about 10 seconds).
2. Release the Default Reset button and wait for the router to reboot.

If the router fails to restart or the power light continues to blink or turns solid amber, the unit may be defective. If the error persists, you might have a hardware problem and should contact technical support.

Appendix A

Technical Specifications

This appendix provides technical specifications for the Router.

Network Protocol and Standards Compatibility

Data and Routing Protocols: TCP/IP, RIP-1, RIP-2, DHCP
PPP over Ethernet (PPPoE)

Power Adapter

North America: 120V, 60 Hz, input
United Kingdom, Australia: 240V, 50 Hz, input
Europe: 230V, 50 Hz, input
Japan: 100V, 50/60 Hz, input
All regions (output): 5 V DC @ 1 A output, 20W maximum

Physical Specifications

Dimensions: 28 x 175 x 118 mm (1.1 x 6.89 x 4.65 in.)
Weight: 0.3 kg (0.66 lb)

Environmental Specifications

Operating temperature: 0° to 40° C (32° to 104° F)
Operating humidity: 90% maximum relative humidity, noncondensing

Electromagnetic Emissions

Meets requirements of: FCC Part 15 Class B
VCCI Class B
EN 55 022 (CISPR 22), Class B

Interface Specifications

LAN: 10BASE-T or 100BASE-Tx, RJ-45
WAN: 10BASE-T, RJ-45

Glossary

Use the list below to find definitions for technical terms used in this manual.

List of Glossary Terms

802.11b

IEEE specification for wireless networking at 11 Mbps using direct-sequence spread-spectrum (DSSS) technology and operating in the unlicensed radio spectrum at 2.5GHz.

802.11g

A soon to be ratified IEEE specification for wireless networking at 54 Mbps using direct-sequence spread-spectrum (DSSS) technology and operating in the unlicensed radio spectrum at 2.5GHz. 802.11g is backwards compatible with 802.11b.

Cat 5

Category 5 unshielded twisted pair (UTP) cabling. An Ethernet network operating at 10 Mbits/second (10BASE-T) will often tolerate low quality cables, but at 100 Mbits/second (10BASE-Tx) the cable must be rated as Category 5, or Cat 5 or Cat V, by the Electronic Industry Association (EIA).

This rating will be printed on the cable jacket. Cat 5 cable contains eight conductors, arranged in four twisted pairs, and terminated with an RJ45 type connector. In addition, there are restrictions on maximum cable length for both 10 and 100 Mbits/second networks.

DHCP

An Ethernet protocol specifying how a centralized DHCP server can assign network configuration information to multiple DHCP clients. The assigned information includes IP addresses, DNS addresses, and gateway (router) addresses.

DNS

Short for Domain Name System (or Service), an Internet service that translates domain names into IP addresses.

Because domain names are alphabetic, they're easier to remember. The Internet however, is really based on IP addresses. Every time you use a domain name, therefore, a DNS service must translate the name into the corresponding IP address. For example, the domain name `www.example.com` might translate to `198.105.232.4`. The DNS system is, in fact, its own network. If one DNS server doesn't know how to translate a particular domain name, it asks another one, and so on, until the correct IP address is returned.

Domain Name

A descriptive name for an address or group of addresses on the Internet. Domain names are of the form of a registered entity name plus one of a number of predefined top level suffixes such as .com, .edu, .uk, etc. For example, in the address mail.NETGEAR.com, mail is a server name and NETGEAR.com is the domain.

DSL

Short for digital subscriber line, but is commonly used in reference to the asymmetric version of this technology (ADSL) that allows data to be sent over existing copper telephone lines at data rates of from 1.5 to 9 Mbps when receiving data (known as the downstream rate) and from 16 to 640 Kbps when sending data (known as the upstream rate).

ADSL requires a special ADSL modem. ADSL is growing in popularity as more areas around the world gain access.

Dynamic Host Configuration Protocol

DHCP. An Ethernet protocol specifying how a centralized DHCP server can assign network configuration information to multiple DHCP clients. The assigned information includes IP addresses, DNS addresses, and gateway (router) addresses.

Gateway

A local device, usually a router, that connects hosts on a local network to other networks.

IP

Internet Protocol is the main internetworking protocol used in the Internet. Used in conjunction with the Transfer Control Protocol (TCP) to form TCP/IP.

IP Address

A four-byte number uniquely defining each host on the Internet, usually written in dotted-decimal notation with periods separating the bytes (for example, 134.177.244.57).

Ranges of addresses are assigned by Internic, an organization formed for this purpose.

ISP

Internet service provider.

Internet Protocol

The main internetworking protocol used in the Internet. Used in conjunction with the Transfer Control Protocol (TCP) to form TCP/IP.

local area network

LAN. A communications network serving users within a limited area, such as one floor of a building. A LAN typically connects multiple personal computers and shared network devices such as storage and printers. Although many technologies exist to implement a LAN, Ethernet is the most common for connecting personal computers.

MAC address

The Media Access Control address is a unique 48-bit hardware address assigned to every network interface card. Usually written in the form 01:23:45:67:89:ab.

Mbps

Megabits per second.

Point-to-Point Protocol

PPP. A protocol allowing a computer using TCP/IP to connect directly to the Internet.

PPPoA

PPPoA. PPP over ATM is a protocol for connecting remote hosts to the Internet over an always-on connection by simulating a dial-up connection.

PPPoE

PPPoE. PPP over Ethernet is a protocol for connecting remote hosts to the Internet over an always-on connection by simulating a dial-up connection.

PPP over ATM

PPPoA. PPP over ATM is a protocol for connecting remote hosts to the Internet over an always-on connection by simulating a dial-up connection.

PPTP

Point-to-Point Tunneling Protocol. A method for establishing a virtual private network (VPN) by embedding Microsoft's network protocol into Internet packets.

router

A device that forwards data between networks. An IP router forwards data based on IP source and destination addresses.

SSID

A Service Set Identification is a thirty-two character (maximum) alphanumeric key identifying a wireless local area network. For the wireless devices in a network to communicate with each other, all devices must be configured with the same SSID.

This is typically the configuration parameter for a wireless PC card. It corresponds to the ESSID in the wireless Access Point and to the wireless network name. *See also* Wireless Network Name and ESSID.

Subnet Mask

A mask used to determine what subnet an IP address belongs to. Subnetting enables a network administrator to further divide an IP address into two or more subnets.

An IP address has two components, the network address and the host address. For example, consider the IP address 150.215.017.009. Assuming this is part of a Class B network, the first two numbers (150.215) represent the Class B network address, and the second two numbers (017.009) identify a particular host on this network.

Subnetting enables the network administrator to further divide the host part of the address into two or more subnets. In this case, a part of the host address is reserved to identify the particular subnet. This is easier to see if we show the IP address in binary format. The full address is: 10010110.11010111.00010001.00001001
The Class B network part is: 10010110.11010111
and the host address is 00010001.00001001

If this network is divided into 14 subnets, however, then the first 4 bits of the host address (0001) are reserved for identifying the subnet.

The subnet mask is the network address plus the bits reserved for identifying the subnetwork. (By convention, the bits for the network address are all set to 1, though it would also work if the bits were set exactly as in the network address.) In this case, therefore, the subnet mask would be 11111111.11111111.11110000.00000000. It's called a mask because it can be used to identify the subnet to which an IP address belongs by performing a bitwise AND operation on the mask and the IP address. The result is the subnetwork address: Subnet Mask 255.255.240.000 11111111.11111111.11110000.00000000
IP Address 150.215.017.009 10010110.11010111.00010001.00001001
Subnet Address 150.215.016.000 10010110.11010111.00010000.00000000

The subnet address, therefore, is 150.215.016.000.

TCP/IP

The main internetworking protocols used in the Internet. The Internet Protocol (IP) used in conjunction with the Transfer Control Protocol (TCP) form TCP/IP.

WAN

Wide Area Network. A long distance link used to extend or connect remotely located local area networks. The Internet is a large WAN.

WEP

Wired Equivalent Privacy is a data encryption protocol for 802.11b wireless networks. All wireless nodes and access points on the network are configured with a 64-bit or 128-bit Shared Key for data encryption.

Wi-Fi

A trade name for the 802.11b wireless networking standard, given by the Wireless Ethernet Compatibility Alliance (WECA, see <http://www.wi-fi.net>), an industry standards group promoting interoperability among 802.11b devices.

Wireless Network Name (SSID)

Wireless Network Name (SSID) is the name assigned to a wireless network. This is the same as the SSID or ESSID configuration parameter.

WPA

Wi-Fi Protected Access (WPA) is a specification of standards-based, interoperable security enhancements that increase the level of data protection and access control for existing and future wireless LAN systems.